

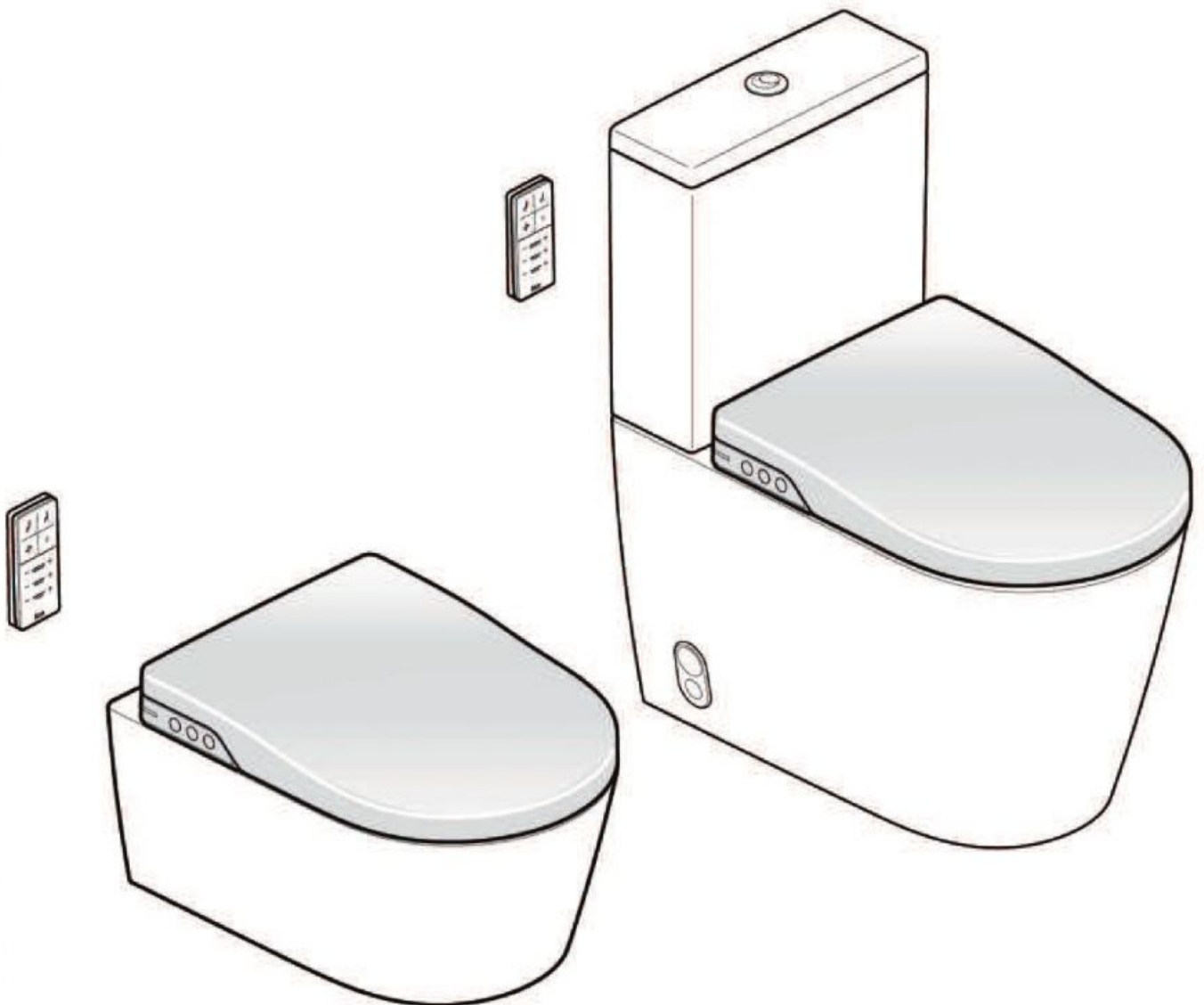

**Roca**

# IN-WASH INSPIRA



ES / EN



<b>1. Safety</b>	26	<b>3.4 Change in the pre-set settings</b>	35
<b>1.1 Warnings - precautions</b>	26	3.4.1 Customisation of the cleaning and drying settings	35
1.1.1 General warnings	26	3.4.2 Operating modes led lights	36
1.1.2 Installation precautions	27	3.4.3 Silence mode	37
1.1.3 Precautions for use	28	<b>3.5 Return to default settings</b>	37
1.1.4 Maintenance precautions	28	<b>3.6 Turning off (Stand-By) / Reset of the product</b>	38
<b>1.2 Environmental conditions</b>	29	<b>4. Cleaning and maintenance</b>	39
<b>2. Introduction</b>	30	<b>4.1 General cleaning</b>	39
<b>2.1 Product parts</b>	30	<b>4.2 Cleaning of the nozzle / tip replacement</b>	40
<b>2.2 Start-up</b>	31	<b>4.3 Descaling of the tip</b>	41
2.2.1 Connection of remote control and self-calibration	31	<b>4.4 Cleaning of the filter</b>	41
2.2.2 Use of the product	31	<b>4.5 Change of batteries in the remote control</b>	42
<b>3. Operation</b>	32	<b>4.6 Stop due to prolonged absence</b>	42
<b>3.1 Functions by remote control</b>	33	<b>4.7 Removal of seat and cover</b>	42
3.1.1 Perineal cleaning function	33	<b>5. Troubleshooting</b>	44
3.1.2 Anal cleaning function	33	<b>6. Technical features</b>	46
3.1.3 Drying function	33	<b>6.1 Features / specifications</b>	46
3.1.4 Stop function	33	<b>7. Disposal of electric and electronic products</b>	46
<b>3.2 Settings with the remote control</b>	34		
3.2.1 Setting of temperature	34		
3.2.2 Setting of water pressure	34		
3.2.3 Setting of position	34		
<b>3.3 Auxiliary side control</b>	34		
3.3.1 Anal cleaning with auxiliary side control	35		
3.3.2 Drying with auxiliary side control	35		
3.3.3 Stop with auxiliary side control	35		

# 1. Safety

## 1.1 WARNING - PRECAUTIONS

Please read this manual carefully before using the product, and keep it at hand for future reference.

A negligence or an incorrect use of the product can lead to serious injuries.

The **In-Wash Inspira** is not suitable to be used by individuals (including children) with physical, sensory or mental disabilities or who lack the experience or knowledge to use it, unless, for their own safety, they are monitored by a responsible person or they receive instructions on how to use it.

Make sure that children do not play with the device.

When using electric devices, basic safety measures should always be followed; make sure you take into account the following:

### 1.1.1 GENERAL WARNINGS

Regarding the packaging:

- The packaging of the **In-Wash Inspira** is not a toy.
- Do not allow children to play with the plastic bags or with the packaging material as they may present a risk of suffocation or injuries. Keep therefore the material in a safe place or get rid of it following the environmental rules.

Regarding the anal and perineal cleaning:

- Do not use the device beyond the time established in each cycle. If you do it, you may be altering your body's natural balance.
- Individuals undergoing medical treatment or therapy in these specific areas should consult with their physician before using this type of product.

Regarding the seat and cover:

- Soft-close seat and cover.
- The dampers in the seat and cover provide a slow and silent closure. Do not press any of these two parts with your hand as you might damage the operation of the damper.





## 1.1.2 INSTALLATION PRECAUTIONS

This product should only be installed by qualified staff and with the provided components. Please check the installation manual in order to obtain more information on the electrical and water connections.

Make sure you fulfil the following precautions regarding the hydraulic installation:

- Always connect the **In-Wash** to the domestic cold water mains.
- Do not use seawater, industrial water or rainwater for the water supply of the **In-Wash**.
- When installing the water filter, make sure it is tightened adequately and in its correct position.
- The pressure of the water supply of this device should be within the range of 0,05 to 0,9 MPa.

Make sure you fulfil the following precautions regarding the electrical installation:

- Do not handle the socket with wet hands: To remove the plug from the power outlet, do not pull the cable, always pull the plug.
- Always unplug the power cable before handling the product.
- Always use the specified supply voltage (220-240V, AC 50/60 Hz). The product should have an earth connection. It is necessary to install a circuit breaker, exclusively devoted to the **In-Wash**.
- Do not use a poor or defective electrical connection.
- Place the socket correctly. It should be properly connected to the power outlet, firmly and completely.
- Remove the dust from the power outlet.
- Do not bend or squeeze the connecting tube or the power cable; and keep the cable away from humid, hot or sharp surfaces.
- Do not install the product in wheeled vehicles or boats.

Ignoring these precautions may cause fire, electric shock, short-circuit or damages to the device.

To confirm that the installation is correct:

- Check that the vitreous china piece is installed according to the provided installation manual.
- Check that the shut-off valve is open.
- Check that the power supply is connected to the **In-Wash**.
- Check that the remote control is connected to the **In-Wash**. (Should this not be the case, please see section 2.2.1).

When the **In-Wash** is connected to the power supply, the lights blink and a long beep may be heard.

The nozzle moves outwards and inwards.

The lights switch off and the **In-Wash** remains in a Stand-by mode, ready to be used.



### 1.1.3 PRECAUTIONS FOR USE

These precautions are important for a safe use. Make sure you follow them and use the product properly.

The **In-Wash Inspira** is a WC that has been designed for the cleaning of the anal and perineal areas. It has been designed mainly for private use. Its use is restricted to enclosed spaces. Any other use will not be deemed in accordance with its purpose and Roca will not accept any responsibility for the consequences that might arise from an improper use.

Should there be an operational failure, please check the Problem resolution chart (see section 5).

To lean back when you are sitting on the **In-Wash** will facilitate the adjustment of the nozzle and will reduce possible splashing.

Do not urinate or splash water or cleaning agents on the main body or the mains plug.

If you do it, you may cause a fire, electric shock, heat or a short-circuit and you may cause stains or a malfunction.

Do not ever obstruct any opening in the product, nor should you drop or insert any objects in them. Keep the air inlet free of lint.

Do not place any open flames, candles, cigarretes or similar items over the product and do not drop flammable items or cigarretes near or inside the product.

Do not step on the product.

Avoid forcing the seat or the cover.

Please do not bend, pull or twist the power cable, nor should you place heavy objects on it.

If there is a water leak, always close the shut-off valve.

Do not use a booster seat for children or adults if you are going to use the **In-Wash**.

To avoid dropping the remote control, place it on its base when you are not using it.

### 1.1.4 MAINTENANCE PRECAUTIONS

Stop the product if you are not going to use it for a long period of time. (Check section 3.6 of this manual).

Do not disassemble or repair the product; please contact Technical Assistance in case of breakdown. Any repairs should be carried out by authorised staff, using original spare parts and accessories.

When you use cleaning agents to clean the WC, clean it and remove it in 3 minutes, leaving the seat and cover always open.

Clean any remains of detergent from the WC bowl. (If the vapour from a WC cleanser enters the main unit, it may cause a malfunction).

## 1.2 ENVIRONMENTAL CONDITIONS

The room temperature should not be below 4°C or over 40°C.

When the room temperature drops below 4°C, avoid damages due to freezing; frozen water pipes could break the **In-Wash** and the pipes, resulting in a water leak; regulate the room temperature to prevent the pipes and hoses from freezing during the cold months.



## 2. Introduction

### 2.1 PRODUCT PARTS

Wall-hung In-Wash Inspira model:

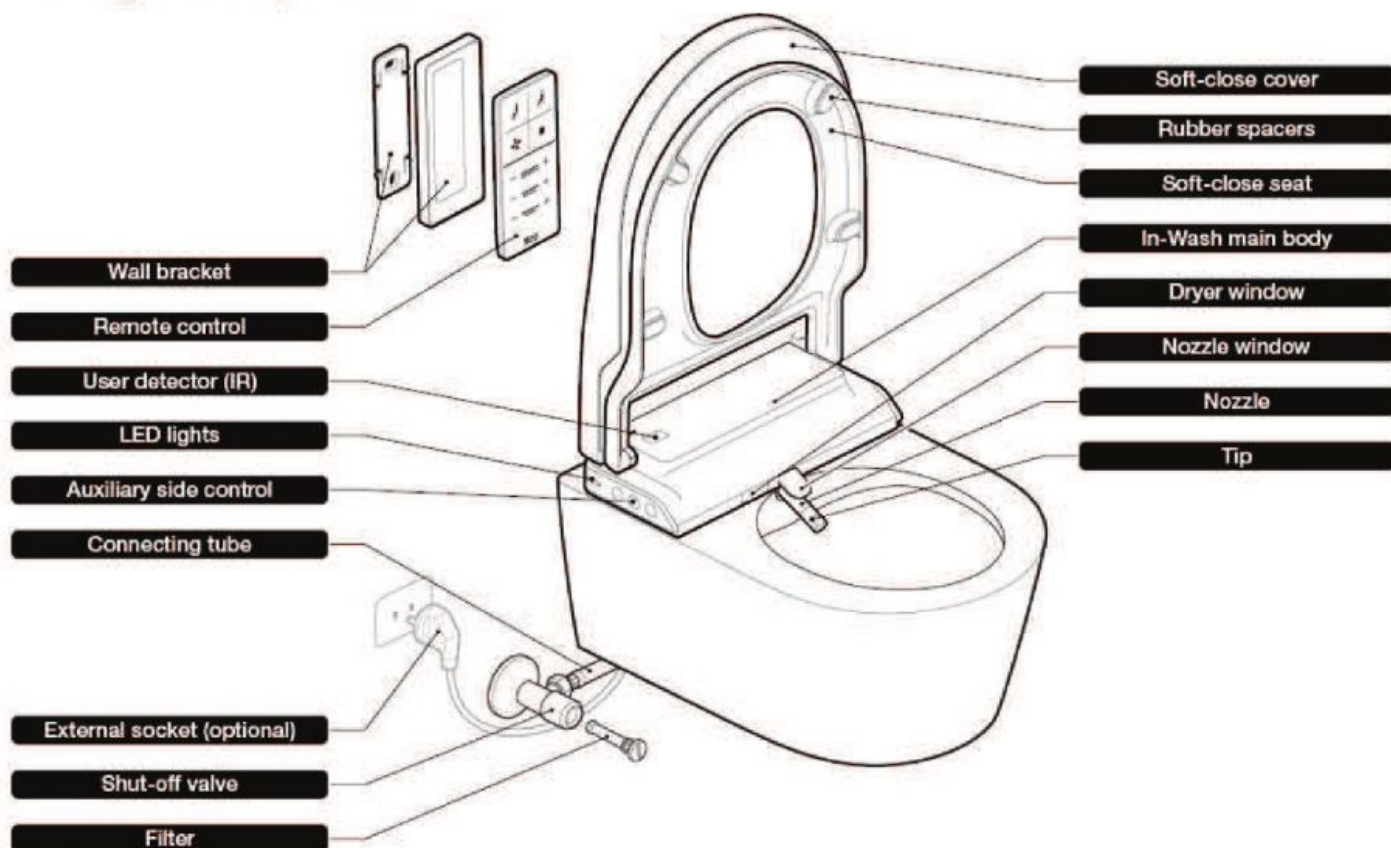

In-Wash Inspira Floorstanding model:

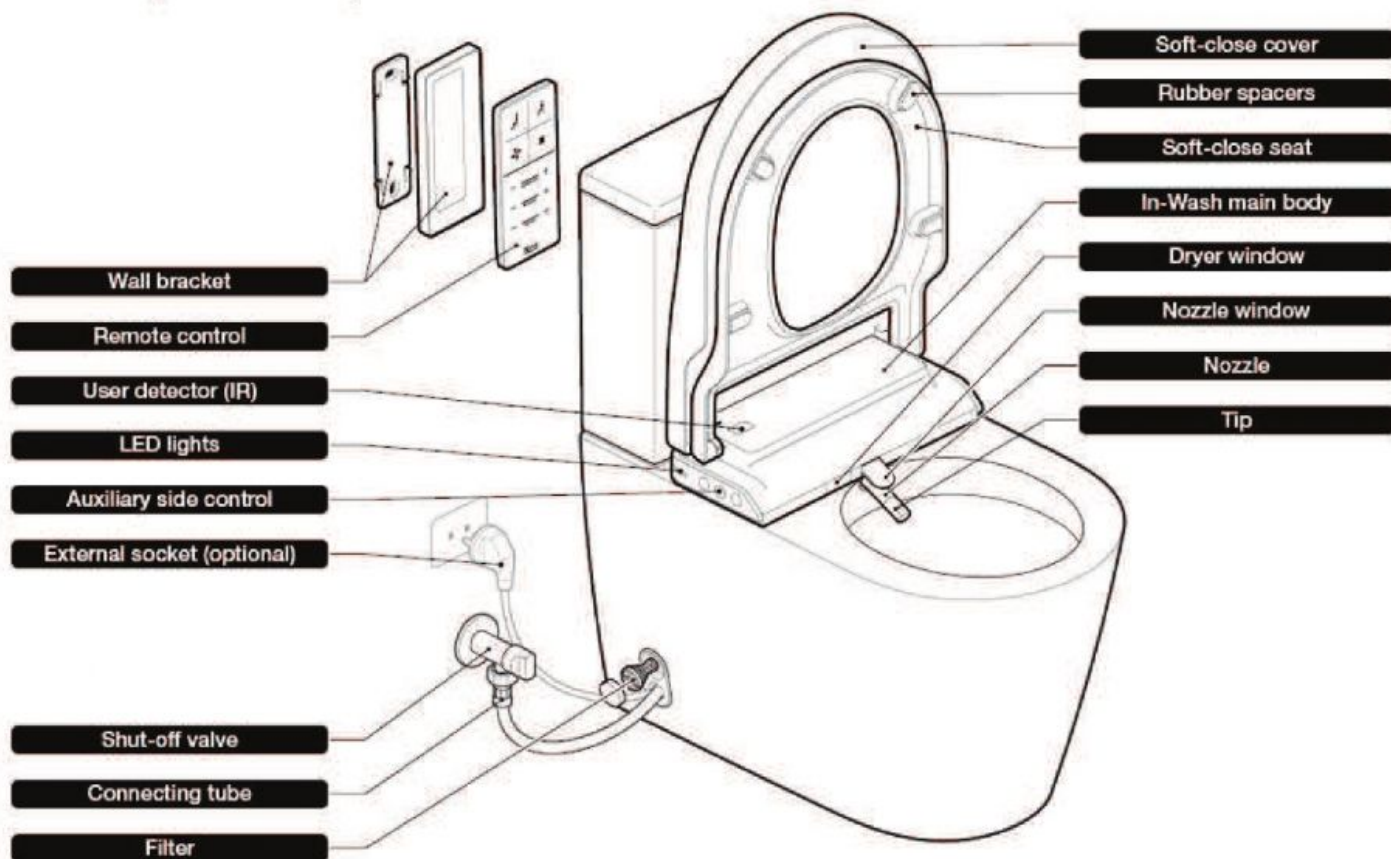

## 2.2 START-UP

### 2.2.1 CONNECTION OF THE REMOTE CONTROL AND SELF-CALIBRATION

To connect the remote control to the In-Wash it is necessary to:

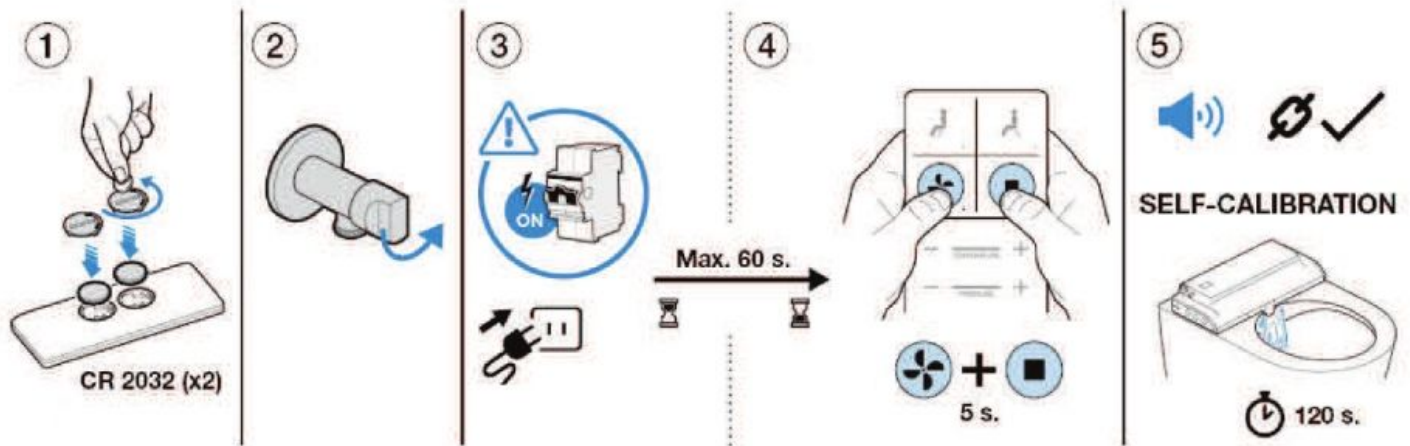

1- Place the batteries inside the remote control.

2- Open water supply valve

3- Activate the power to supply the In-Wash.

4- After connecting the power, you have 60 seconds to link the remote control, pressing simultaneously the *Drying* and *Stop* buttons on the remote control for 5 seconds.

5- A beep will be heard and all the LEDs on the remote light up, as a signal that it is connected. A self-calibration process starts for 120 seconds during which water flows from the e-bidet nozzle window.

Do not disconnect the device during this process.

Should the connection be incomplete, repeat the process starting from step 2.

### 2.2.2 USE OF THE PRODUCT

The **In-Wash** has a small internal water tank that is cold in stand-by conditions.

When the user detector detects a seated user, the preheating process is activated.

The preheating takes place at 36°. The functions may be activated at any time, but if they are activated too soon, the water will not have time to reach the established temperature; therefore it is recommended a minimum preheating period of 30 seconds from the moment the **In-Wash** detects the user until any water function is activated.

When a function is activated, the **In-Wash** carries out a cleaning of the nozzle before its use.

When the function is finished, a subsequent cleaning process of the nozzle takes place for 10 seconds.



# 3. Operation

The functions may only be activated when the cover is open and the device detects a user.

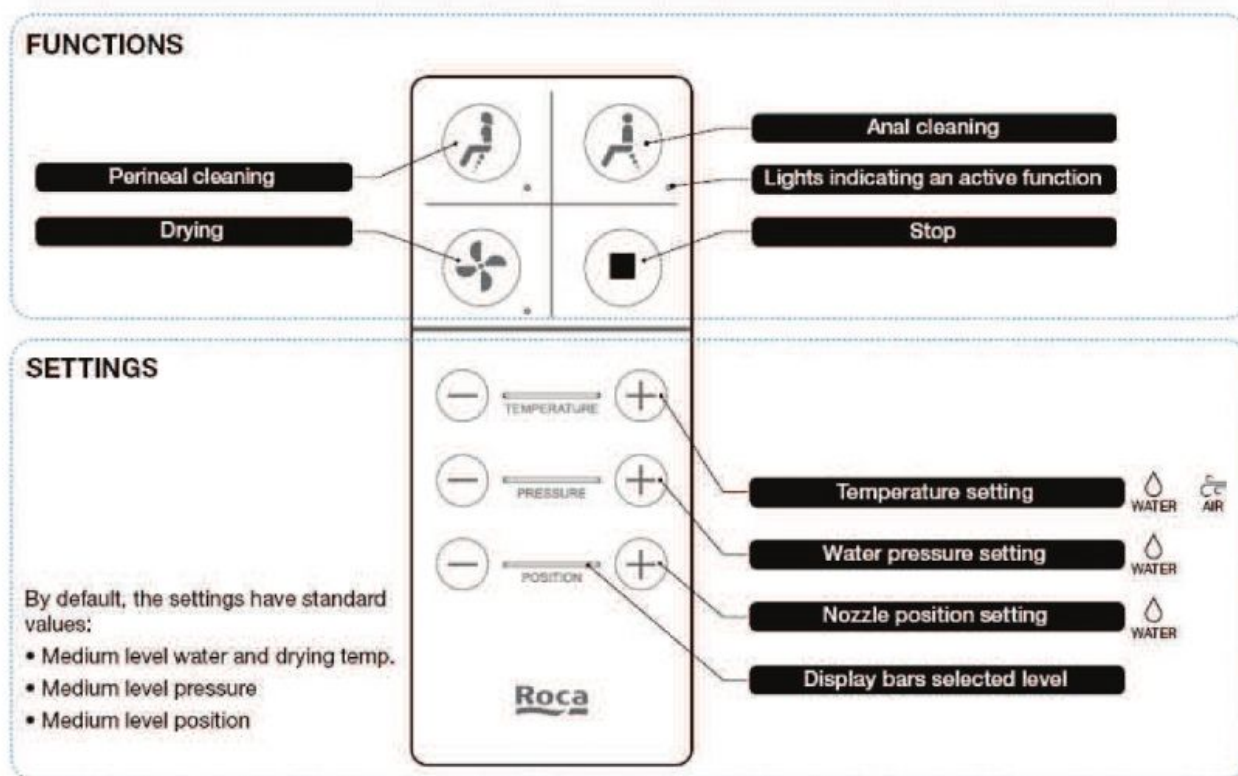

It is possible to modify the pre-set standard values, customising them to suit the customer's needs. See section 3.4.1

When pressing any button of the remote control, the leds are activated, informing us of the active function and the settings that have been selected.

The leds switch off 5 seconds after showing that information.

## 3.1 FUNCTIONS BY REMOTE CONTROL

### 3.1.1 PERINEAL CLEANING FUNCTION

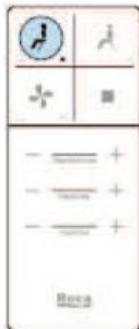

By selecting this function the nozzle is activated in the advanced position (for female cleaning).

With the function activated, if the same button is pressed again the **oscillating** function is activated. If it is pressed again, we return to the normal mode (not oscillating).

While using this function it is possible to adjust:

- Water temperature.
- Water pressure.
- Position of the nozzle to adjust it properly to the user.

To stop this function, press the *Stop* button on the remote control or on the auxiliary side control.

The cleaning stops after 2 minutes if no other button is pressed.

If another function is chosen while the cleaning is taking place, the cleaning stops and the selected function is activated.

### 3.1.2 ANAL CLEANING FUNCTION

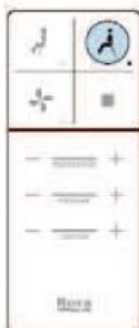

By selecting this function the nozzle is activated in the rear position.

With the function activated, if the same button is pressed again the **oscillating** function is activated. If it is pressed again, we return to the normal mode (not oscillating).

While using this function it is possible to adjust:

- Water temperature.
- Water pressure.
- Position of the nozzle to adjust it properly to the user.

To stop this function, press the *Stop* button on the remote control or on the auxiliary side control.

The cleaning stops after 2 minutes if no other button is pressed.

If another function is chosen while the cleaning is taking place, the cleaning stops and the selected function is activated.

### 3.1.3 DRYING FUNCTION



This function provides air for drying after the cleaning functions.

While using this function it is possible to adjust:

- Air temperature.

To stop this function press the *Stop* button on the remote control or the auxiliary side control.

The drying stops after 3 minutes if no other button is pressed.

If another function is chosen while the drying is taking place, the drying stops and the selected function is activated.

### 3.1.4 STOP FUNCTION

It stops any active function.

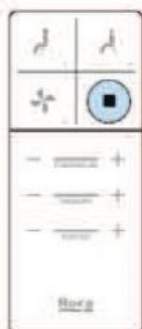



## 3.2 SETTINGS WITH THE REMOTE CONTROL

### 3.2.1 SETTING OF TEMPERATURE

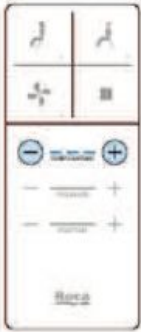

The water and air functions have a temperature setting.

The water temperature has 4 levels:

- Room temperature (no led is switched on)
- Low temperature 33°C (1 led switched on)
- Medium temperature 36°C (2 leds switched on)
- High temperature 39°C (3 leds switched on)

The air temperature can be adjusted in 4 levels:

- Room temperature (no led is switched on)
- Low temperature (1 led switched on)
- Medium temperature (2 leds switched on)
- High temperature (3 leds switched on)

By pressing the plus symbol we can obtain a higher temperature and by pressing the minus symbol, a lower temperature.

### 3.2.2 SETTING OF WATER PRESSURE

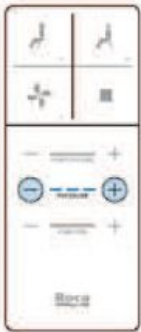

The cleaning water pressure may be modified obtaining a higher or lower water force in 3 levels.

By pressing the plus symbol we can obtain a higher force and by pressing the minus symbol, a lower force.

### 3.2.3 SETTING OF POSITION

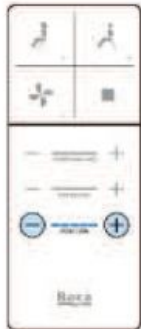

The nozzle can be adjusted in 5 positions. By default it starts in a middle position allowing the user to advance two positions and to move backwards two positions.

## 3.3 AUXILIARY SIDE CONTROL

The auxiliary side control can be used to monitor the main product functions: Anal cleaning and dryer.

This auxiliary side control allows the use with medium settings.

These settings may not be customised:

- Medium temperature
- Medium pressure
- Middle position

The functions may only be activated when the lid is open and the device detects a user.

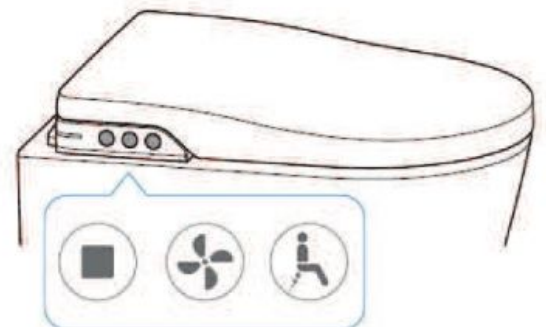

### 3.3.1 ANAL CLEANING WITH AUXILIARY SIDE CONTROL



The position of the nozzle is established beforehand; so is the water temperature.

With the function activated, by pressing the same button again the **oscillating** function is activated. If it is pressed again, it returns to the normal mode (not oscillating).

To stop this function, press the *Stop* button on the auxiliary side control or on the remote control.

The cleaning stops after 2 minutes if no other button is pressed.

If the drying button is pressed while the anal cleaning is taking place, the cleaning stops and the drying is activated.

### 3.3.2 DRYING WITH AUXILIARY SIDE CONTROL



The drying function is established beforehand with a medium temperature.

To stop this function press the *Stop* button on the remote control or the auxiliary side unit. The drying stops after 3 minutes if no other button is pressed.

### 3.3.3 STOP WITH THE AUXILIARY SIDE PANEL



It stops any activated function.

## 3.4 CHANGE IN THE PRE-SET SETTINGS

### 3.4.1 CUSTOMISATION OF THE CLEANING AND DRYING SETTINGS

The **In-Wash** allows you to change the pre-set Temperature, Pressure and Position settings, which are controlled by the remote control.

By default, these baseline values are:

- Medium temperature: 36° perineal and anal.
- Medium pressure: 0.55 L/min in perineal, 0.75 L/min in anal.
- Position- 3 Perineal, 3 Anal.

To set a different value to the pre-set one, with the activated function, adjust each of the temperature, pressure or position parameters to the desired level and press the + and - buttons simultaneously on the remote control for 3 seconds.

Each temperature, pressure or position parameter needs to be set individually.

When the setting has been carried out, the **In-Wash** emits a beep and the lights in the remote control blink.

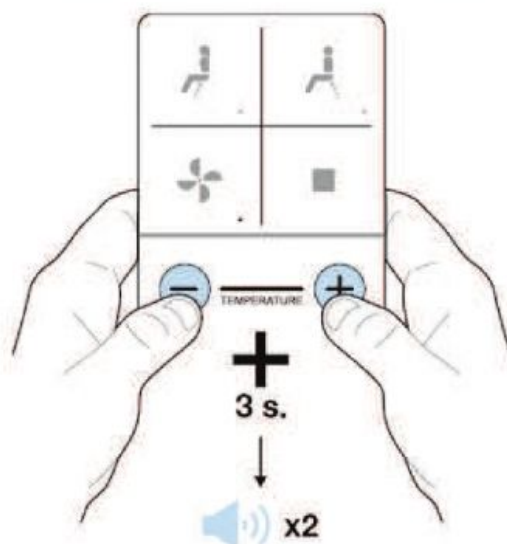



Therefore, if you wish to change the 3 settings of the anal cleaning, by instance, they should be pressed successively with the activated function

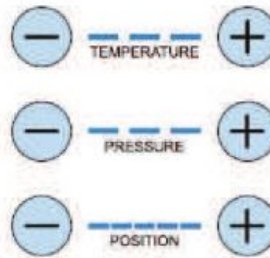

Should you need to connect the remote control again these stored values would be lost.

To return to the pre-set standard values, see section 3.5.

### 3.4.2 OPERATING MODES LED LIGHTS

There are four operating modes for light in the **In-Wash**:

#### Mode 1 Standard:

This is the pre-set mode of the product.

The lights remain switched off while the **In-Wash** is not in use.

When the cover is lifted, the lights are switched on. They remain switched on while the product is in use and they switch off one minute after they stop detecting the user.

#### Mode 2 Standard with night light:

When this mode is activated, the lights of the **In-Wash** switch on daily for 8 hours and during the remaining 16 hours the **In-Wash** remains in Standard mode.



#### Mode 3 Night light:

When this mode is activated, the lights of the **In-Wash** switch on daily for 8 hours and they remain switched off for the remaining 16 hours.

#### Mode 4 Switched off:

Lights always switched off.

The Light mode may be modified by means of the auxiliary side control:

-  • Press the *Dryer* button on the auxiliary side control for 3 seconds. A beep will be heard and the lights will blink indicating the mode of the **In-Wash**; 1 blink + 1 beep mode 1, 2 blinks + 2 beeps mode 2 and so on.
-  • Press successively the *Dryer* button to change the mode 1, 2, 3, 4, 1, 2, 3, 4... until you reach the desired mode. The lights blink 1, 2, 3 or 4 times indicating the selected mode.
-  • With the selected mode, press the *Stop* button on the auxiliary side control or the remote control, to memorise the option, or wait one minute and the last selected mode will be registered.

### 3.4.3 SILENCE MODE

The **In-Wash** offers the option of silencing the sound it emits when activating the functions and settings.

To silence it, with the auxiliary side control, press the *Drying* and *Stop* buttons simultaneously for 3 seconds.

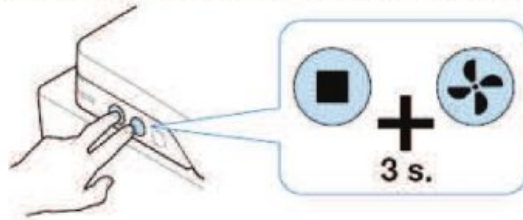

### 3.5 RETURN TO DEFAULT SETTINGS

To return to the default settings press the *Drying* and *Stop* buttons on the remote control simultaneously for 5 seconds.

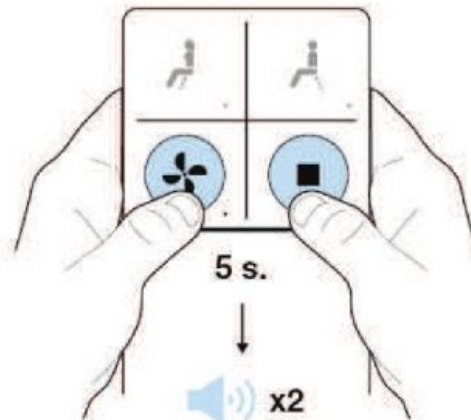

All previously modified values will be deleted and the **In-Wash** will have its default settings:

- Medium water and drying temperature.
- Medium pressure.
- Middle position.
- Light mode 1 (standard).
- It will also carry out a product self-calibration test, in which water flows out of the nozzle for 2 minutes.
- Silence mode disconnected.



### 3.6 TURNING OFF (STAND-BY) / RESET OF THE PRODUCT

To switch off the In-Wash, press the Stop button on the auxiliary side control for 3 seconds.

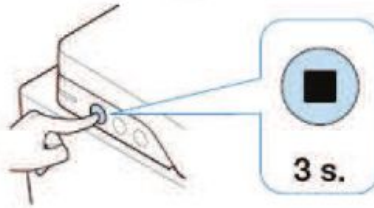

To reactivate the In-Wash, press the Stop button on the auxiliary side control.

From that moment on the device carries out a power self-calibration for 2 minutes; during this period of time water flows out of the nozzle.

Do not disconnect the device during this process.

#### RESET

The reset process consists in a stand-by manoeuvre followed by the activation of the product.

Each time this process is carried out, a power self-calibration will be carried out for 2 minutes.

## 4. Cleaning and maintenance

### 4.1 GENERAL CLEANING

#### CLEANING OF THE REMOTE CONTROL

Clean it softly with a wet cloth.

If the remote control is very dirty, you may use diluted neutral detergent.

Do not remove the cover of the batteries during its cleaning.

#### CLEANING OF THE DEVICE

Clean the outside of the device with care using a soft and wet cloth or a sponge.

#### Important:

1. Do not use aggressive products such as bleaches or ammonia. Use only neutral product.
2. Do not pull or push the nozzle manually. To remove it see section 4.2
3. While cleaning the WC leave the cover open for a few hours so that gases do not enter the In-Wash.
4. Do not spray the water or the air outlets with water or cleaning agents that may enter inside the In-Wash.

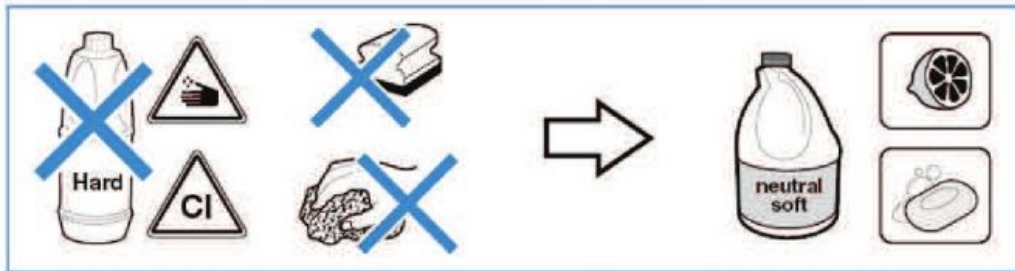



## 4.2 CLEANING OF THE NOZZLE / TIP REPLACEMENT

We recommend cleaning the nozzle and the tip weekly.

The e-bidet is provided with one additional tip with 3 holes for a more intense cleaning. This second tip can be used to replace the installed tip.

To remove the nozzle or change the tip, follow this steps:

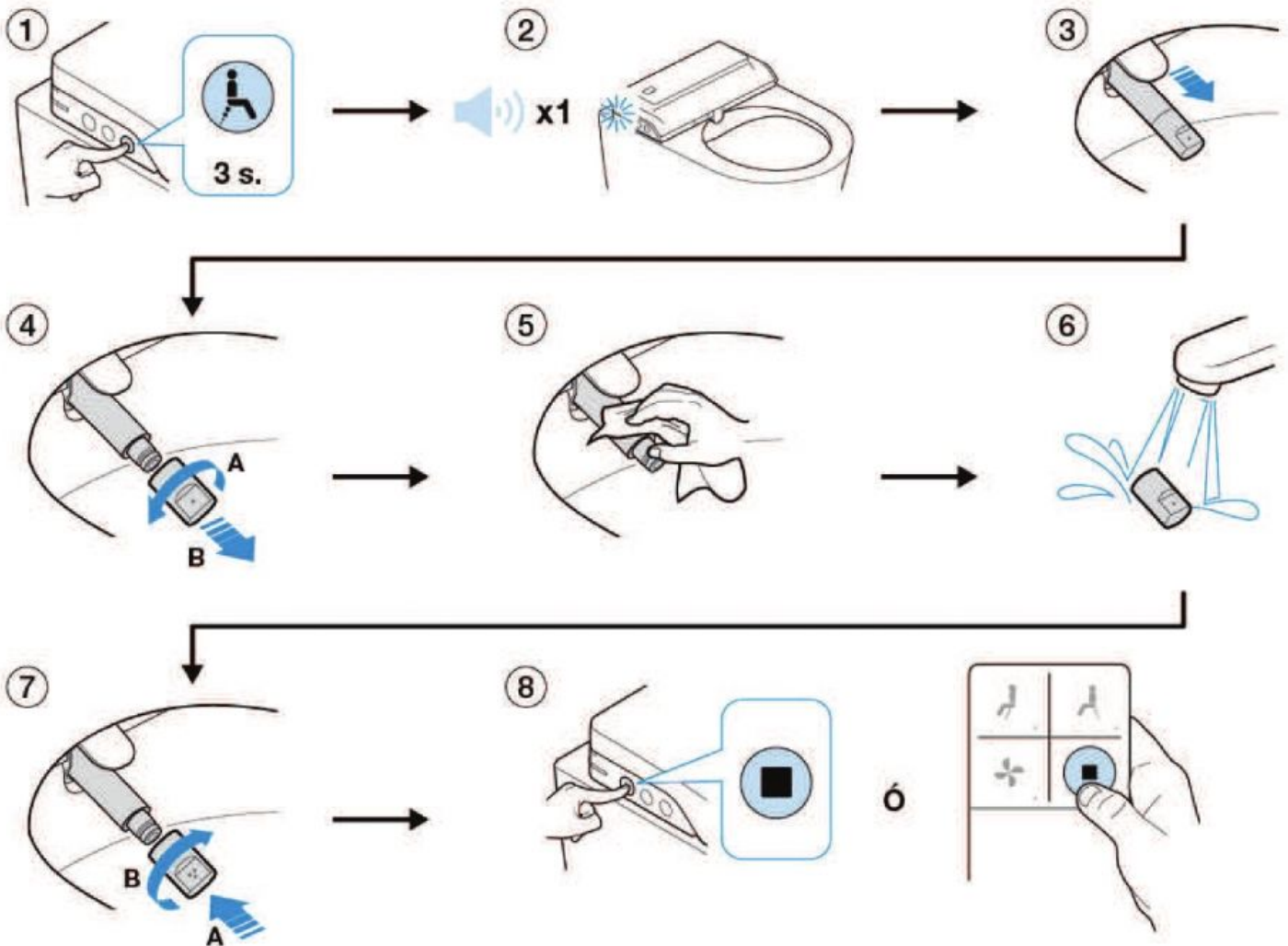

- 1- Press the anal cleaning button on the auxiliary side control for 3 seconds.
- 2- The lights blink and a beep can be heard (if the silence mode is not activated).
- 3- The nozzle will come forward without spraying any water.
- 4- Remove the tip by rotating it in an anti-clockwise direction.
- 5- Clean the nozzle.
- 6- Clean the tip.
- 7- Replace the tip on the nozzle.
- 8- Once the cleaning is finished, press the Stop button on the remote control or the auxiliary side control. Should you fail to do so, the nozzle will move backwards automatically after 5 minutes. Once inside, it carries out a self-cleaning process.

### 4.3 DESCALING OF THE TIP

The holes in the tip may get blocked up due to limescale. Should this occur, the water flow diminishes and the lights on the equipment blink 3 times, signaling that the tip must be descaled.

To descale it, immerse it in a liquid anti-limescale available in the market. Rinse and reinstall.

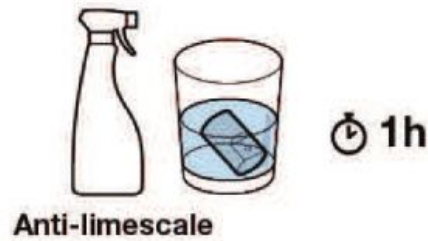

### 4.4 CLEANING OF THE FILTER

We recommend carrying out the maintenance of the filter once every year to ensure a correct functioning of the device.

For the wall-hung model:

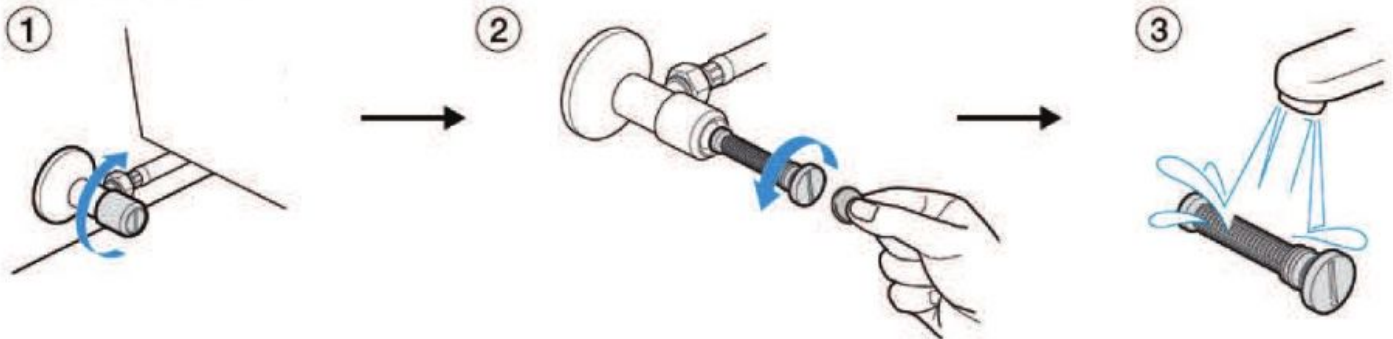

1. Close the shut-off valve.
2. Remove the filter with a screwdriver or a coin.
3. Clean the filter.
4. Replace the filter in its position ensuring it is properly installed and reopen the shut-off valve.

For the floorstanding model:

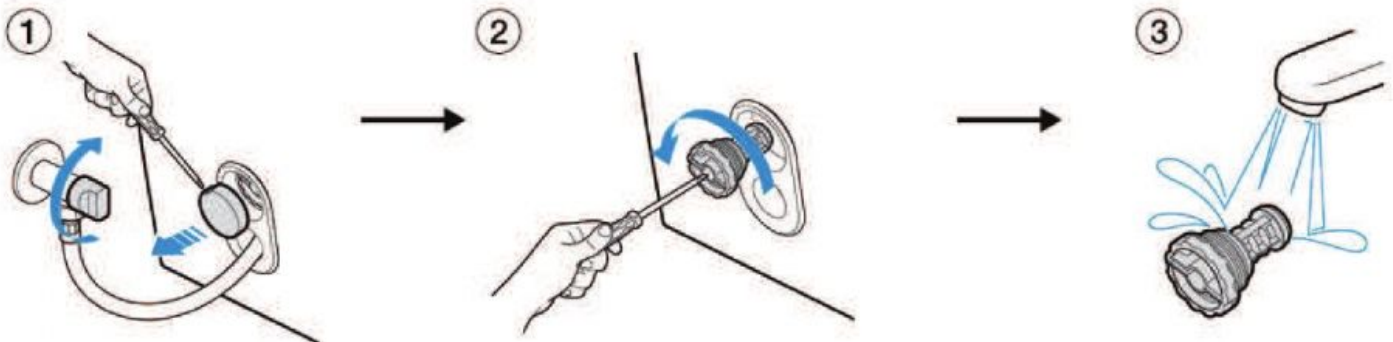

1. Close the shut-off valve.
2. Remove the filter with a screwdriver or coin.
3. Clean the filter.
4. Replace the filter in its position ensuring it is properly installed and reopen the shut-off valve.



## 4.5 CHANGE OF BATTERIES IN THE REMOTE CONTROL

The batteries needed for the remote control are two button batteries type CR-2032.

We recommend not mixing new and used batteries or batteries from different brands.

The remote control indicates that the batteries are running low with a quick blinking of the leds after a use. They should be replaced then.

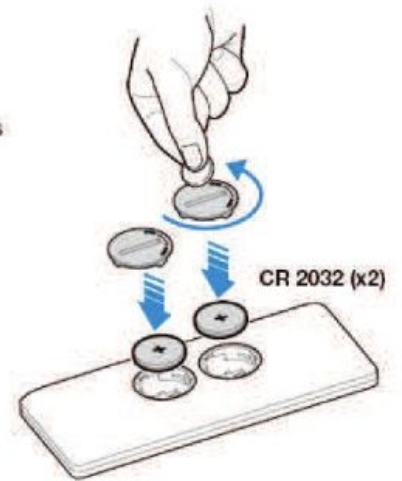

## 4.6 STOP DUE TO PROLONGED ABSENCE

If a long time elapses without using the In-Wash we recommend switching to Stand-By mode. See section 3.6

## 4.7 REMOVAL OF SEAT AND COVER

To remove the seat and cover, slide the internal side tab upwards and carry out the movement described in the image; raise the side of the turned tab and slide it sideways towards the opposite side.

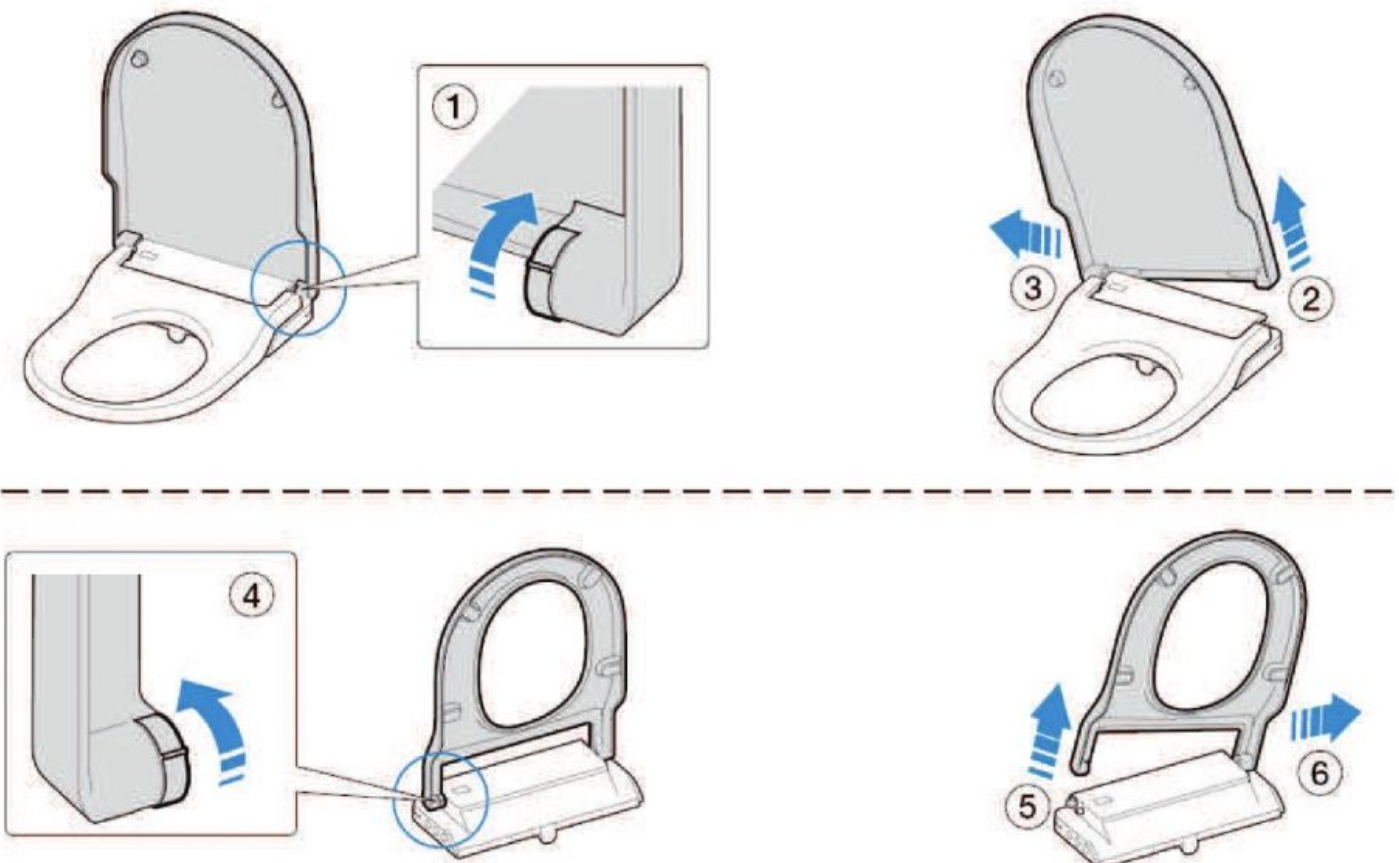

To replace the seat and cover carry out the operation in reverse.

**Important warning:**

If you remove the dampers when extracting the seat and cover, it is important to take into account their position, as a change in their position may seriously damage the product.

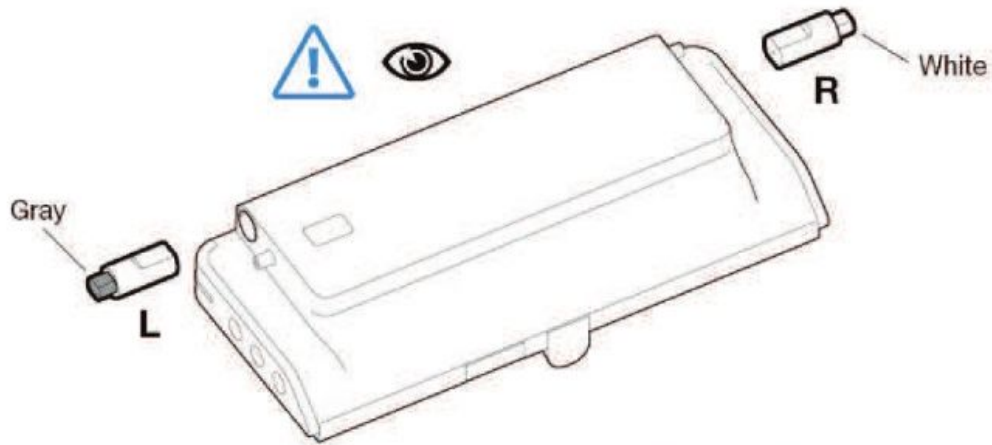

The white damper is located on the right side (to cushion the seat) and the grey one is on the left (to cushion the cover).



## 5. Troubleshooting

PROBLEM	POSSIBLE CAUSE	SOLUTION
The product does not respond to the auxiliary side panel	The device is turned off.	Press the Stop button on the auxiliary side panel.
	The product is unplugged or disconnected.	Connect the device to the mains.
The product does not respond when pressing the remote control or the leds of the remote control do not switch on.	The batteries of the remote control are dead.	Replace the batteries. (See 4.1.4).
	The batteries of the remote control are not properly placed.	Verify that the batteries are placed in the correct position (See 4.1.4).*
All leds in the remote control are blinking.	The batteries in the remote control are running low.	Replace the batteries.
The product does not respond when pressing the remote control and the leds in the functions area of the remote blink.	The device is turned off.	Press the Stop button on the auxiliary side panel.
	The remote control is not connected to the e-bidet.	Connect the remote control. (See 2.2.1)
	The remote control cannot be connected to the e-bidet. (The batteries are new and they are correctly placed).	*
No function activates and a beep can be heard.	The user is not seated properly and the sensor is not working.	Correct your position. *
The water flow is lower than usual and the lights blink three times every 5 seconds.	The water outlets in the tip might be blocked due to limescale.	Descale the tip (See 4.1.2) and reset the product. (See 3.6) *
The cleaning function stops.	The pre-set cleaning time of 2 minutes has expired.	This is normal. Activate the cleaning function again.
	The infrared sensor has stopped detecting the user. If the position during use is too forward, the device might stop detecting the user.	Sit down correctly. Reactivate the cleaning function. *
	Failure of power supply.	Verify the electrical system or unplug and plug in the cable to the mains.
The cleaning function stops and the lights blink twice every 5 seconds.	Not enough water is entering the In-Wash. The shut-off valve is closed or there is a general supply failure.	Verify there is water supply from the mains and reset the product (See 3.6).
	Not enough water is entering the In-Wash. The water inlet filter is blocked.	Clean the water filter (See 4.1.3) and reset the product (See 3.6).
	Not enough water is entering the In-Wash. The inlet flexible hose is pinched or bent.	Reposition the inlet flexible hose and reset the product (See 3.6).*
	Not enough water is entering the In_Wash for no previous reason.	*
The cleaning function stops and the lights blink twice every 5 seconds.	The water outlets of the tip might be blocked due to limescale or there is a blockage in the water circuit.	Descale the tip of the nozzle and reset the product (See 3.6). *
The cleaning function stops and the lights blink 4 or 5 times every 5 seconds.	The water has heated up excessively.	Reset the product (See 3.6). *
The cleaning water is not warm.	The water is adjusted to room temperature.	The water is adjusted to room temperature.
The cleaning water is not warm and the lights blink 6 times every 5 seconds,	The water heating tank is not working.	Reset the product (See 3.6). *

PROBLEM	POSSIBLE CAUSE	SOLUTION
The cleaning water is not warm and the lights blink 7 times every 5 seconds.	The temperature sensors are not working correctly.	Reset the product (See 3.6). *
The nozzle does not move backwards.	The power supply has been cut.	Restore the power connection. The nozzle will move backwards automatically.
	The engine of the nozzle has lost its position.	Reset the product. (See 3.6). *
The drying stops or it does not work.	The pre-set drying time of 3 minutes has expired.	This is normal. Reactivate the drying function.
	The infrared sensor has stopped detecting the user. If the position during use is too forward, the device might stop detecting the user.	Sit down correctly. Reactivate the cleaning function. *
The temperature of the drying air is not warm enough.	The temperature of the drying air is set to room temperature.	Increase the temperature by means of the remote control.
	The air heater is not working.	*
The seat moves when sitting down.	The rear brackets of the seat are not tight enough.	Tighten the rear brackets of the seat.
* Should the problem persist, please call the Technical Assistance.		



## 6. Technical features

### 6.1 FEATURES / SPECIFICATIONS

SPECIFICATIONS		
Model		In-Wash INSPIRA
Power supply		220-240V AC
Frequency		50/60Hz
Max. power input		1700W
Heat output	Water heater	1650 W
	Hot air dryer	300 W
Temperature range	Service temperature	10°C / 30°C
	Water temperature 4 levels	OFF / 33 / 36 / 39°C
	Temperature of the warm air dryer 4 levels	OFF / 40 / 50 / 60°C
	Storage temperature	-10°C / 60°C
Water pressure		0,05 Mpa / 0,9 Mpa (0,5 bar - 9 bar)
Cleaning	Flow perineal position	0,45 – 0,55 – 0,65 l/min
	Flow anal position	0,65 – 0,75 – 0,85 l/min
	Safety devices	Fuse and Thermostat
Drying	Air speed of the dryer	8,5 m/s
	Safety device	Fuse
Length of the connecting cable		1,5 M
Remote control		Button batteries (CR2032) x2
		Radio frequency (band 2,4GHz )
Night light		Yes
Energy savings		Automatic intelligent energy savings
Size of the product	Wall-hung model	L562xW380xH420 (mm)
	Floorstanding model	L675xW380xH790(mm)
Weight of the product	Wall-hung model	31 kg (±1kg)
	Floorstanding model	55 kg (±1kg)
Protection class		IP X4
Consumption in stand-by		<0,7W

## 7. Disposal of electric and electronic products



NOTE: This symbol and recycling system is only applicable in the European Union. It does NOT apply to the rest of the world.

At ROCA we are committed to protecting the environment. Please help us by discarding this product at the end of its life-cycle in a responsible manner, to prevent that certain substances contained in electrical or electronic equipment may cause harm to human health and the environment.

The crossed-out wheeled bin symbol, shown above and on the product, means that it should not be discarded with other household waste. At the end of the product's life-cycle, it must be delivered to the corresponding collection facilities enabled by the authorities in your country or to the supplier from which you purchase a product of equivalent type or that fulfills the same functions as the previous equipment. This last option may not be available in some countries, so please check with the authorities in your country about the collection systems available and the collection facility closest to your home.

This way, you can cooperate with the protection of the environment through the reuse and recycling of waste electrical and electronic equipment. On the contrary, administrative responsibilities can be derived for you in case of non-compliance with the rules for the delivery of the waste of this product.

Batteries shall be previously removed and discarded separately in suitable recycling containers.







Roca Sanitario, S.A.  
Avda. Diagonal, 513  
08029 Barcelona  
SPAIN  
[www.roca.com](http://www.roca.com)

**902  
304  
848**  **LÍNEA DE  
ATENCIÓN AL  
CONSUMIDOR  
ESPAÑA**

**902  
400  
423**  **SERVICIO  
TÉCNICO  
ESPAÑA**

  
[productsupport.rs@roca.net](mailto:productsupport.rs@roca.net)  
[soporteproducto.rs@roca.net](mailto:soporteproducto.rs@roca.net)